

M12 male 0° / RJ45 male 0° shielded Ethernet

TPE 22AWG SF/UTP CAT5e gn UL/CSA, ITC/PLTC 35m

Ethernet CAT5

Plastic housings with good resistance against chemicals and oils.

Male straight – male straight

M12 – RJ45, 4-pole

D-coded

shielded

USA

without cable sleeves

Protection cap

Further cable lengths on request.

[Link to Product](#)

Illustration

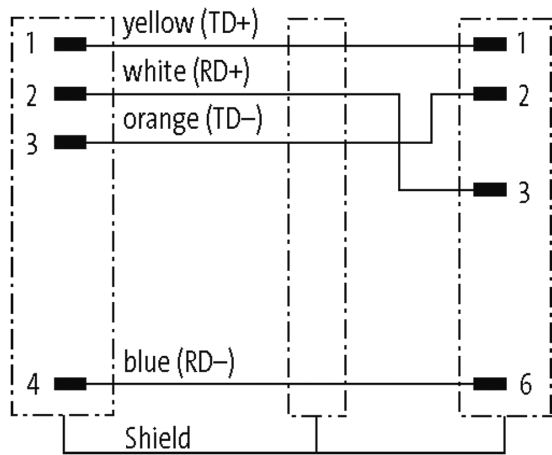
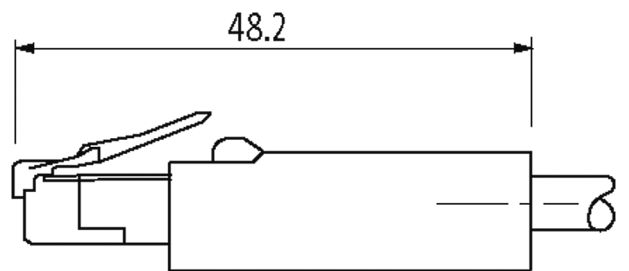
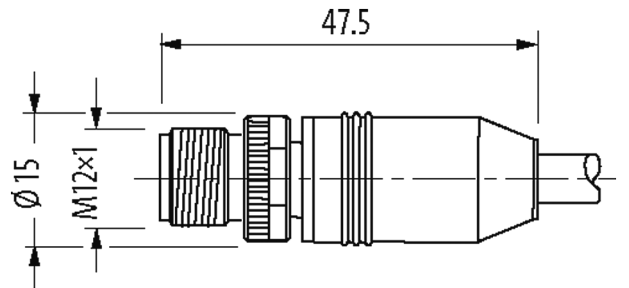

Product may differ from Image

Approvals

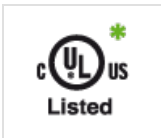

* only for products with UL/CSA approved cable

More Info



EtherNet/IP

Form

Form

44711

General data	
Standards	DIN EN 61076-2-101 (M12)
Mounting method	inserted, tightened
Pollution Degree	3
Temperature range	-25...+85 °C, depending on cable quality
Cables	
Cable number	S7V
No./diameter of wires	2× 2× 0.34 mm ²
Wire isolation	HDPE (wh, ye, bl, or)
C-track properties	1 Mio.
Jacket Color	green
Material (jacket)	TPE (UL)
Outer Ø	7.9 mm ±5%
Bend radius (moving)	10× outer Ø
Temperature range (fixed)	-40...+80 °C
Temperature range (mobile)	-20...+80 °C
Cable identification	S7V
Cable weight [g/m]	74,80
Material (wire)	Cu wire, tin plated
Construction (core)	19× 0.16 mm (multi-strand wire class 5)
Diameter (core)	2× 2× 0.34 mm ²
Material (wire isolation)	HDPE
Wire-Ø incl. isolation	1.42 mm ±5%
Shield	yes
Material (jacket)	TPE
Outer-Ø (jacket)	7.9 mm ±5%
Color (jacket)	green
Bend radius (fixed)	5× outer Ø
Torsion stress	3 Mio.
Technical Data	
Operating voltage	max. 60 V DC
Operating voltage (only UL listed)	30 V DC
Rated surge voltage	1.0 kV
Operating current per contact	max. 1.5 A (20 °C)
No. of poles	4
Material group	IEC 60664-1, category I
Transfer parameters	CAT5, Class D (ISO/IEC 11801:2002), (EN 50173-1)
Transfer rate	up to 100 Mbit/s full duplex
Coding	M12, D-coded
LED display	no
Locking of ports	Screw thread (M12×1 mm) recommended torque 0.6 Nm, self-securing
Compression gland	M12 (SW13)
Protection	IP67 (M12) - IP20 (RJ45)
Locking material	Zinc die casting, matte nickel plated (M12)
Material	PUR
suitable for corrugated tube (internal Ø)	without
Commercial data	

country of origin	DE
customs tariff number	85444210
EAN	4048879701006
eClass	27061801
Packaging unit	1

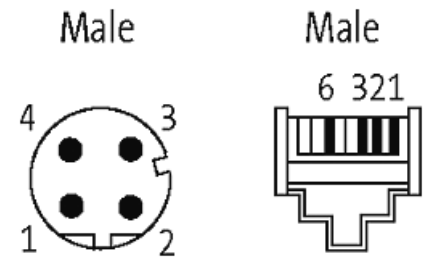
Sketch

Product may differ from Image